

ADAYO

ADAYO

**2023-2024
NEW CATALOGUE**

OEM&ODM Manufacturing
vendor of LED lighting



adayo-led



adayoled

T : +86-752-5300 980

+86-752-5300 977

F : +86-752-5300 099

+86-752-5300 979

+86-752-5300 601

E : info@adayoled.com

A : Foryou Industrial Park Area B, No.1 North Shangxia Road, Dongjiang

Hi-tech industry Park, Huizhou, Guangdong Province, P R China

HUIZHOU FORYOU OPTOELECTRONICS TECHNOLOGY CO., LTD.



INDEX

Large downlights

Die-casting & metal downlights

STARK : Die-casting module downlight series	014-018
STARK-H : High efficiency	014-018
STARK-U : UGR<19	014-018
STARK-C : COB LED	014-018
STARK-D : Diffuser	014-018
STARK-T : Tilttable	014-018
MAGIC HAT : UGR22 built-in driver	019-020
DE GAULLIST : UGR19 external driver	019-020

Other downlights

EIFFEL : Module downlight series	022-038
EIFFEL-E : ECO DOB built-in driver	022-023
EIFFEL-S : Standard external driver	024-029
EIFFEL-U : UGR<19&22	030-032
PIZZA Multi-fit Flat Downlight	033-038

Small Downlights

Die-casting & metal downlights

MAGIC : Slim&modular	039-042
ROLAND : 360° Rotatable	043-044
JAMES : 360° Rotatable Eco	045-046
COREIN : modular	047-048
CLOVER : Fire-rated	049-050
ROLAND iii : Fire-rated&360°rotatable	051-058
MIRANDA : Deep recessed G1.5	059-060
MINI EYES : MINI size	059-060
ROSEY : ECO DOB built-in driver	061-062

Small Downlights

Other downlights

AMBER : DIY slim	064-064
SOFIA : DIY G3	065-066
AVALOR : DIY G4	065-066
CLIO : DIY large	067-068
BAGEL : Cabinet light	069-070

Spotlights

PEGGY : Surface mounted linear	071-072
EMILY : Surface mounted round	073-073
BOX : Surface mounted cuboid	074-075
EMILY II : Platform	076-076
GIRAFFE : Recessed	077-077

Ceiling Light & Bulkhead Light

Adeline : Northen design	078-079
Moon : Indoor IP54 platform	080-081
Muffin : Outdoor IP66 IK10	082-084
Pipe : Tri-proof tube	085-086
Ben : Tri-proof linear	085-086
Backlit Panel	087-087

Light source module and GU10

Fair : Retrofit eco module	089-090
REP 50 : Retrofit die-casting module	091-092
GECO : ECO GU10	093-094
Noah : Long lifespan	095-096



▲ Foryou Industrial Park

PROFILE

Foryou Corporation

Established in **1993**, listed in **2017**
 Leading in auto electronics of China
2,000+ R&D engineers
 Auto Industry Quality Control System
560,000 square meters industrial park

Top 100 Electronic Information
 Enterprises Of China
Top 100 Enterprises In Guangdong
Top 500 Manufacturers of China
500 Most Influential Brands of Asian

About us



Huizhou Foryou Optoelectronic Technology Co., Ltd (ADAYO lighting) is a wholly-owned subsidiary of Foryou corporation, which entered the LED packaging industry in 2006, and established in 2012 with registered capital of 32 million US dollar. There are three business lines: LED package, LED high power driver and LED lighting. We are good at ODM, OEM projects and also can provide self-developed products for every target market.

Our advantage

■ Listed Company

ADAYO corporation was listed on the Shenzhen Stock Exchange in 2017 stock code: 002906; We have strong capital strength to provide best payment terms and long time warranty. With the help of Foryou corporation, we are able to get very competitive price and service from our suppliers and then provide our products with competitive price and service also.

■ Professional sales team

For different countries, we have regional sales consultants who work in the LED lighting industry more than 10 years and can provide most suitable proposal to your request.



■ Quality control

15 people with more than 10 years of experience in quality control of LED lighting industry provide you with high quality products with cost-effective price. We have very strict quality control process based on international commercial lighting customers' projects request which can ensure best quality for new products as well as mass productions.



■ R&D Team

We have an R&D team of 30 people for led lighting ,driver, structural design, some of them have more than 20 years of experience in the lighting industry. We invested USD3000000 for international standard laboratory which covered 1200m² and more than 100 instruments and equipment can perform 21 tests of LED lighting



■ Brand customer cooperation experience

More than 10 years of cooperation experience with international brands in the LED industry and regional brands in various markets as well as customers for DIY stores and supermarkets.

■ Euro local consultants

Professional consultants in different countries to provide latest design, products developing advice to meet the request of different local markets for residential, commercial, industrial lighting in North Euro, France, UK and rest of the Euro markets;

Professional certification

We passed ISO9001,ISO14001,BSCI,CE,CB,FCC,UL,SAA,BS476-20,BS476-21 and other international certifications.



Main Business

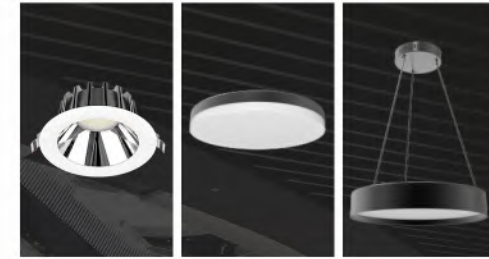

LED Lighting



LED Package



New energy

Large downlights

Metal downlight

■ STARK Die-casting module downlight



DL14 014 DL14 015 DL14 016 Flat Slight

■ STARK-H: High efficiency

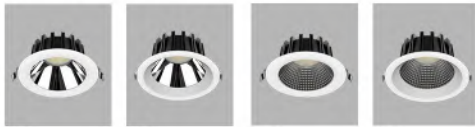

DL14 016 DL14 016 DL14 016 DL14 016

■ STARK-U: UGR<19

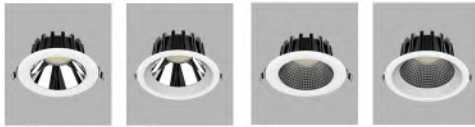

DL14 017 DL14 017 DL14 017 DL14 017

■ STARK-C: COB LED



DL14 016 DL14 016

■ STARK-D: Diffuser



DL14 014 DL14 015

■ STARK-T: Tilttable



DL15 018

■ MAGIC HAT: UGR22 built-in driver



DL060-6 019 DL060-8 019

■ DE GAULLIST: UGR19 external driver



DL005-B4S 020 DL005-B6S 020 DL005-B8S 020

Other downlights

■ EIFFEL-E: ECO DOB built-in driver

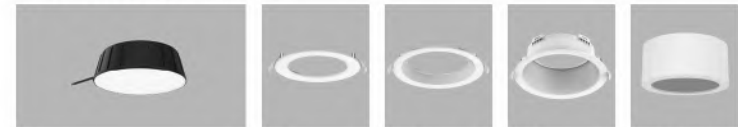

DL10 022 Flat 022 Slight 022 Deep 022 Surface-mounted 022

■ EIFFEL-S: Standard external driver

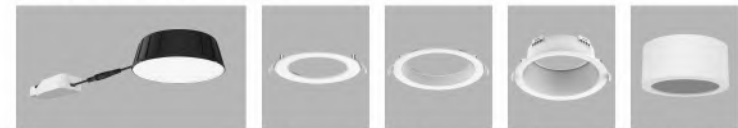

DL10 024 Flat Slight Deep Surface-mounted

■ EIFFEL-U: UGR<19&22



DL10-D30 030 DL10-EM6006 031 DL013-A01C 032

■ PIZZA Multi-fit Flat Downlight



DA50M-6A 034 DA65M-18A 034 DA95M-23A 034 DA65M-D 035 DA65M-P 036 DA65M-E 037

Small Downlights

Die-casting downlights

■ MAGIC: slim&modular



SL11 039 SL11 039 SL11 041 SL11 041 Round Fixed Round Adjustable Square Fixed



Square Adjustable Round Fixed Deep Round Fixed Deep Round Fixed Deep Round Fixed Deep Round Fixed Round Adjustable



Square Fixed Square Adjustable Round Fixed Deep Round Fixed Deep Round Fixed Deep Round Fixed Deep

■ ROLAND: 360° Rotatable



YA30K-A01 043 YA25K-A01 043 YK30K-A02 044 YK25K-A02 044 SL06-A2501 045 SL06-A2502 046

■ JAMES: 360° Rotatable Eco

■ COREIN: modular



SL005-A01 048 SL005-B01 048 SL005-FR01 049 SL005-FR02 049 SL005-FR03 049 SL005-FR04 049



SL005-FS01 049 SL005-FS02 049

■ CLOVER: Fire-rated



SL002-C01 052



SL002-B01 053



SL002-A03 054

■ ROLAND III Fire-rated



SL360-A03F 055



SL361-A03F 056

■ CLOVER VI Fire-rated

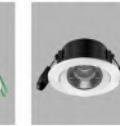

SL360-A03F 057



SL361-A03F 058

■ MIRANDA: Deep recessed G1.5



SL015-W065 059



SL015-W044 059



SL015-N065 059



SL015-N044 059

■ MINI EYES: MINI size



SL004-A01 060



SL004-A03 061

■ ROSEY: ECO DOB built-in driver



SL08-A01 063



SL08-B01 063

Other downlights

■ AMBER DIY slim



YD-25L 064



YA-25L 064



YA-25M 064

■ SOFIA DIY G3



DY25H-A01 065



DY25H-B01 065



DY25H-C01 065



HY25H-C01 065
CLASS A

■ AVALOR DIY G4



SL05-B25 066



SL05-C25 066



SL05-A25 066



SL05-D25-IP65 067



SL05-D25-IP44 067

■ CLIO: DIY large



YD35J-A01 068



YA35J-B01 068



YD35J-D01S 068

■ BAGEL: Cabinet light



DL008-A01 069



DL008-B01 069

Spotlights

■ PEGGY: Surface mounted linear



SP001-A01B 072 SP001-A02B 072 SP001-A03B 072 SP001-A04B 072

■ EMILY: Surface mounted round ■ BOX: Surface mounted cuboid



SP001-D01B 073 SP001-D03B 073 SP001-E01W 075 SP001-E02W 075 SP001-E04W 075

■ EMILY II: Platform



SP004-RD1 076 SP004-SM1 076 SP004-TR1 076 076

■ GIRAFFE: Recessed



SL09-SQ1 077 SL09-SQ2 077 SL09-SQ3 077

Ceiling Light & Bulkhead Light

■ Adeline: Northern design ■ Moon: Indoor IP54 platform



On/Off 078 WIFI RGBCW 078 On/Off 081 Sensor 081 Emergency 081 CL04-400-B 081 CL04-500-C 081

■ Muffin: Outdoor IP66 IK10

■ Pipe: Tri-proof tube

■ Ben: Tri-proof linear



On/Off 082 Sensor 083 Emergency 083 CL03-220-B 084 LB02-A600 085 LB03-A600 086 Backlit Panel 087

Light source module and GU10

■ Fair: Retrofit eco module

■ REP 50: Retrofit die-casting module



SL003-A01 089 SL003-B01 089 SL003-C01 089 MODULE-COB 092 MODULE-COB 092 MODULE-SMD 092 MODULE-SMD 092

■ GECCO: ECO GU10



SL003-GU10B01 093 SL003-GU10B02 093 SL003 093 SL003-GU10B01 CLASS A 093

■ Noah: Long lifespan



SL003-GU10-C05 095 SL003 095

STARK

Die-casting module downlight series

Modular design

IP54 and IK05

Die-casting housing and frames

Longlifespan:50000hrs

CCT seletable and Power selectable

Replaceable lightsource and driver

3 different housing to avoid competition

5 series to meet different projects

STARK-H: High efficiency: Up tp 140lm/W

STARK-U: UGR<19& up to 130lm/W

STARK-C: COB LED

STARK-D: Diffuser

STARK-T: Tiltable



Diffuser version



Flat



Slight



Reflector COB version



Flat



Slight



Reflector SMD version



Flat



Slight



STARK-D Diffuser



NEW

KEY FEATURES

- IP54
- Module design
- Die casting heat sink
- Light source and driver are replaceable
- 3 types of frames available: Flat frame slight frame, deep frame.
- $\geq 120\text{lm/W}$
- 2CCT (3000K-4000K)
- Fast connector 3 loop in 3 loop out
- Different designs for die-casting housing optional
- 50000hrs lifespan, 5years warranty



Specifications

Module	DL14-B30	DL14-B40	DL14-B60	DL14-B80
Total Power	7W-13W	12.5W-19W	17W-24W	33W-40W
Lumen	850-1400 lm	1500-2200 lm	2200-3100 lm	4200-5200 lm
CCT	3000K-4000K			
Beam angle	100°			

Dimensions

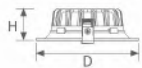

B30	D:Φ110mm H:65mm Cut:Φ90mm
B40	D:Φ146mm H:70mm Cut:Φ120mm
B60	D:Φ176mm H:75mm Cut:Φ150mm
B80	D:Φ226mm H:85mm Cut:Φ200mm



Multi-Power & CCT Switchable



Frame option

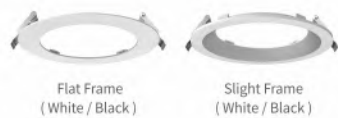

NEW

KEY FEATURES

- High lighting efficiency 140lm/W
- IP54
- Module design
- Different color of reflector to choose
- Die-casting trim and housing
- Different designs for die-casting housing optional
- 50000hrs lifespan, 5 years warranty



Specifications

Module	DL14-C30	DL14-C40	DL14-C60	DL14-C80
Total Power	6.4-10.4W	10.4-15.5W	13.5-20W	16-23.5W
Lumen	720-1250 lm	1250-1950 lm	1800-2700 lm	2100-3400 lm
CCT	2700K/3000K/4000K			
Beam angle	60°			

Dimensions (Slight Frame)

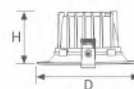

C30	D:Φ110mm H:65mm Cut:Φ90mm
C40	D:Φ146mm H:73mm Cut:Φ120mm
C60	D:Φ176mm H:85mm Cut:Φ150mm
C80	D:Φ226mm H:95mm Cut:Φ200mm



Multi-Power & CCT Switchable



Frame option



Color of reflector optional



STARK-U UGR<19

NEW



KEY FEATURES

- UGR<19 & Up to 140LM/W
- IP54
- Module design
- Replaceable source and driver
- Different color of reflector to choose
- Die-casting trim and housing
- Different designs for die-casting housing optional
- 50000hrs lifespan, 5 years warranty



Specifications

Module	DL14-C30	DL14-C40	DL14-C60	DL14-C80
Total Power	6.4-10.4W	10.4-15.5W	13.5-20W	16-23.5W
Lumen	720-1250 lm	1250-1950 lm	1800-2700 lm	2100-3400 lm
CCT	2700K/3000K/4000K			
Beam angle	60°			

Dimensions (Slight Frame)

C30	D:Φ110mm	H:65mm	Cut:Φ90mm
C40	D:Φ146mm	H:73mm	Cut:Φ120mm
C60	D:Φ176mm	H:85mm	Cut:Φ150mm
C80	D:Φ226mm	H:95mm	Cut:Φ200mm

Multi-Power & CCT Switchable

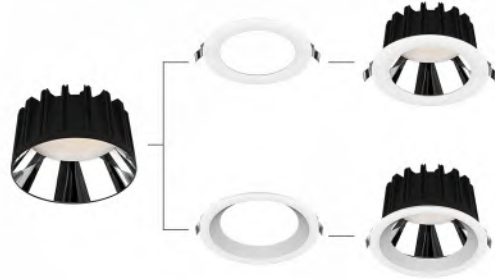
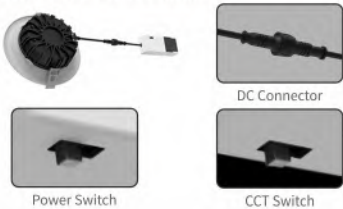

Frame option

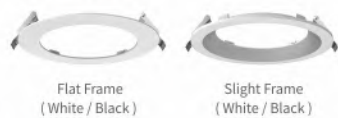

Color of reflector optional



NEW



KEY FEATURES

- COB LED, more uniform light;
- UGR<19 & Up to 140LM/W
- IP54
- Module design
- Replaceable source and driver
- Die-casting trim and housing
- Different designs for die-casting housing optional
- 50000hrs lifespan, 5 years warranty



Specifications

Module	DL14-C30	DL14-C40	DL14-C60	DL14-C80
Total Power	6-10W	10-16W	15-20W	28-34W
Lumen	850-1330 lm	1390-2130 lm	2200-2850 lm	3990-4700 lm
CCT	2700K/3000K/4000K			
Beam angle	60°			

Dimensions (Slight Frame)

C30	D:Φ110mm	H:65mm	Cut:Φ90mm
C40	D:Φ146mm	H:73mm	Cut:Φ120mm
C60	D:Φ176mm	H:85mm	Cut:Φ150mm
C80	D:Φ226mm	H:95mm	Cut:Φ200mm

Multi-Power & CCT Switchable

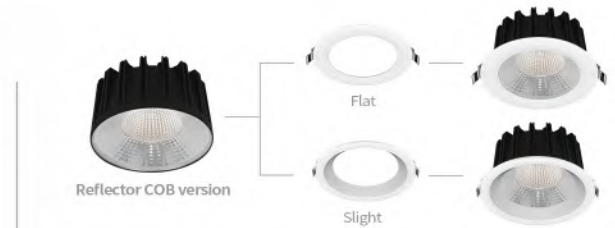

Frame option



STARK -T Tilttable

NEW



KEY FEATURES

- Tilttable Module design
- Can be rotated 355° horizontally
- Light source and driver are replaceable
- 2CCT selectable (3000K-4000K)
- High brightness COB chip
- Different designs for die-casting housing optional
- 50000hrs lifespan, 5years warranty



Specifications

Module	DL15-A30	DL15-A40
Total Power	10W	15W
Size	Φ110x74mm	Φ150x74mm
Cutout	Φ90mm	Φ120mm
Lumen	1300lm	2000lm
CCT	3000K-4000K	
Beam angle	60°	

Finish option



DC Connector & CCT Switchable



Dimensions

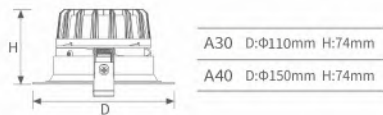

A30 D:Φ110mm H:74mm
 A40 D:Φ150mm H:74mm



MAGIC HAT



Application

Mall, Hall, Meeting Room, Hotel etc.

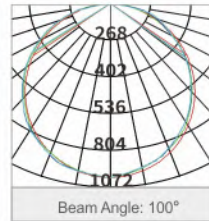

Features

- Anti-glare. UGR<22
- Integrated design, easy to install
- Alu frame

Heat Sink

Good heat dissipation performance



Quick install

Screw free
Loop in loop out

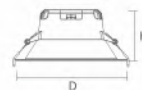

Model	Wattage	Lumen	CCT	Beam	Cut hole	Dimensions
DL060-6	12W	1000lm	2700K/4000K/6500K	100°	φ150mm	φ173x98mm
DL060-8	21W	2100lm			φ206mm	φ233x106mm

DE GAULLIST



Application

Office, Shopping Mall, Hotel , Airport etc.

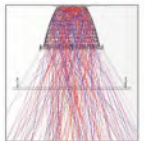
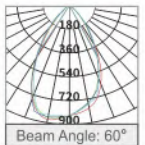
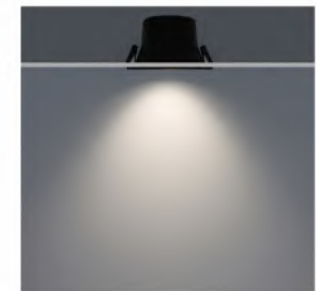

Features

- Anti-glare. UGR<14 & UGR<19
- Up to 120lm/W
- Integrated Alu housing
- Long lifespan 50,000hrs
- Multi-power and CCT3 optional
- 5 years warranty

Reflector Optional

White Change

Silver

CCT3

CCT3 changeable switch on back



Multi - Power

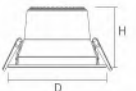

Model	Wattage	Lumen	CCT	UGR	Beam	Cut hole	Dimensions
DL005-B4C	6W-9W-12W	760/1120/1500 lm	CCT3	19/14	60°/38°	φ125mm	φ145x92mm
DL005-W6C	9W-12W-15W	1140/1520/1860 lm	CCT3	19/14	60°/38°	φ150mm	φ175x110mm
DL005-B8C	15W-20W-25W	1920/2520/3060 lm	CCT3	19/14	60°/38°	φ200mm	φ220x140mm

EIFFEL

MODULE DOWNLIGHT



Deep recessed downlight
(Diffuser)



Deep recessed downlight
(Reflector)



Surface-mounted downlight
(Diffuser)



Slight recessed downlight
(Diffuser)



Flat recessed downlight
(Diffuser)

DOB built-in driver module

Module



CCT3
CCT3 changeable switch
on back



Extention Recessed Trim



Flat recessed trim
White/Black



Slight recessed trim
White/Black



Deep recessed trim
White/Black

Color of reflector optional



Surface-mounted Trim



Surface-mounted Frame
2 colors: White / Black

EIFFEL



Application

Mall, Hall, Meeting Room, Hotel etc.

Features

- DOB built-in driver module optional
- CCT selectable
- High lighting efficiency 100lm/W
- IP54 for room side
- 30000hrs lifespan, 3 years warranty

Module design

Module can work with different trims



CCT3

CCT3 changeable switch on back

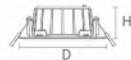

Model	Wattage	Lumen	CCT	Beam	Cut hole	Dimensions Flat trim
DI10-A30	6W	540lm	CCT3	100°	φ90mm	φ106x38mm
DI10-A40	9W	980lm			φ120mm	φ131x38mm
DI10-A60	15W	1600lm			φ150mm	φ168x41mm
DI10-A80	21W	2350lm			φ200mm	φ214x41mm

External driver module

Module

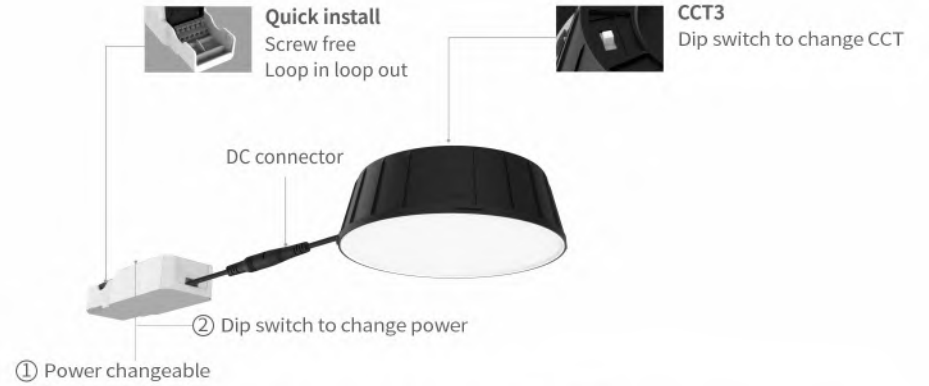

Extention Recessed Trim



Surface-mounted Trim



Surface-mounted Frame
2 colors: White / Black

EIFFEL

EIFFEL



IP54



Application

Mall, Hall, Meeting Room, Hotel etc.

Features

- Module design
- CCT selectable
- High lighting efficiency 100lm/W
- Up to **120lm/W** for some items
- IP54 for room side
- Tool free installation
- 50000hrs lifespan, 5 years warranty



Module design

The module can work with different trims



CCT3

CCT3 changeable switch on back



Quick install

Screw free
Loop in loop out



Power selectable

Dip-switch change the power

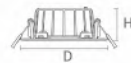

Model	Wattage	Lumen	CCT	Beam	Dim	Cut hole	Dimensions		
DL10-A30A	6W	600lm	CCT3	100°	Triac Dim	φ90mm	φ106x38mm		
DL10-A40A	9W	1000lm				φ120mm	φ131x38mm		
DL10-A60A	15W	1750lm				φ150mm	φ168x41mm		
DL10-A80A	21W	2550lm			φ200mm	φ214x41mm			
DL10-A30B	6W	600lm			CCT3	100°	Non Dim	φ90mm	φ106x38mm
DL10-A40B	9W	1000lm						φ120mm	φ131x38mm
DL10-A60B	15W	1750lm	φ150mm	φ168x41mm					
DL10-A80B	21W	2550lm	φ200mm	φ214x41mm					



IP54



Application

Mall, Hall, Meeting Room, Hotel etc.

Features

- Module design
- CCT selectable
- High lighting efficiency 100lm/W
- Up to **120lm/W** for some items
- IP54 for room side
- Tool free installation
- 50000hrs lifespan, 5 years warranty



Module design

The module can work with different trims



CCT3

CCT3 changeable switch on back



Quick install

Screw free
Loop in loop out



Power selectable

Dip-switch change the power

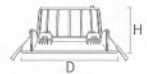
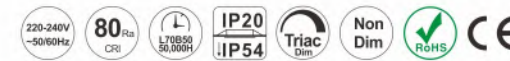

Model	Wattage	Lumen	CCT	Beam	Dim	Cut hole	Dimensions		
DL10-B30A	6W	570lm	CCT3	100°	Triac Dim	φ90mm	φ110x52mm		
DL10-B40A	9W	960lm				φ120mm	φ146x52mm		
DL10-B60A	15W	1650lm				φ150mm	φ175x54mm		
DL10-B80A	21W	2400lm			φ200mm	φ226x54mm			
DL10-B30B	6W	600lm			CCT3	100°	Non Dim	φ90mm	φ110x52mm
DL10-B40B	9W	1000lm						φ120mm	φ146x52mm
DL10-B60B	15W	1750lm	φ150mm	φ175x54mm					
DL10-B80B	21W	2550lm	φ200mm	φ226x54mm					

EIFFEL SENSOR



KEY FEATURES

- PIR Sensor
- IP54 for room side
- 3CCT selectable (3000K-4000K-6500K)
- 50000hrs life span, 5years warranty



Specifications

Modle	DL10-PIR
Total Power:	9W
Size:	Φ201x53mm
Cutout:	Φ160mm
Lumen:	900lm
CCT Changeable:	3000K-4000K-6500K
Beam angle:	100°

Dimensions

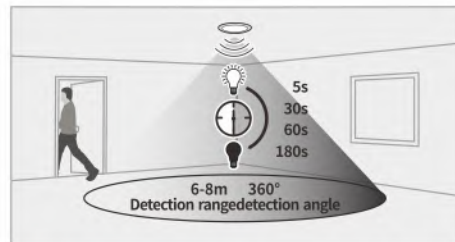
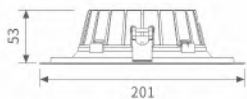

Power & CCT Switchable



EIFFEL



Features

- Module design
- CCT selectable
- High lighting efficiency 100lm/W
- IP54 for room side
- Tool free installation
- 50000hrs lifespan, 5 years warranty



Module design

The module can work with different trims



Quick install

Screw free
Loop in loop out



CCT3

CCT3 changeable switch on back



Power selectable

Dip-switch change the power



Model	Wattage	Lumen	CCT	Beam	Cut hole	Dimensions
DL10-C30	6W	500lm			φ90mm	φ110x71mm
DL10-C40	9W	880lm			φ120mm	φ146x85mm
DL10-C60	15W	1580lm	CCT3	100°	φ150mm	φ175x87mm
DL10-C80	21W	2350lm			φ200mm	φ225x87mm



Application

Mall, Hall, Meeting Room, Hotel etc.

Color of reflector optional



EIFFEL

EIFFEL



Features

- Module design
- CCT selectable
- High lighting efficiency 100lm/W
- Up to **120lm/W** for some items
- Tool free installation
- 50000hrs lifespan, 5 years warranty



Application

Mall, Hall, Meeting Room, Hotel etc.

Finished optional



Black



White

Module design

The module can work with different trims



Quick install

Screw free
Loop in loop out



CCT3

CCT3 changeable switch on back



Power selectable

Dip-switch change the power



Model	Wattage	Lumen	CCT	Beam	Efficacy	Finish	Dim	Dimensions
DL10-G60A	15W	1600lm	CCT3	100°	110lm/W	Black/White	Triac Dim	φ150x75mm
DL10-G80A	21W	2350lm						φ200x75mm
DL10-G60B	15W	1750lm						φ150x75mm
DL10-G80B	21W	2550lm	CCT3	100°	120lm/W	Black/White	Non Dim	φ200x75mm



Features

- UGR<19/22
- Aluminum reflector
- CCT selectable, SDCM<6
- High lighting efficiency 120lm/W
- IP54 for room side
- Tool free installation
- 50000hrs lifespan, 5 years warranty

Module design

The module can work with different trims



Quick install

Screw free
Loop in loop out



CCT3

CCT3 changeable switch on back



Power selectable

Dip-switch change the power

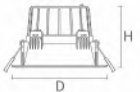
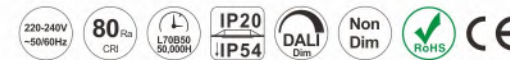

Model	Wattage	Lumen	CCT	Beam	Dim	Cut hole	Dimensions
DL10-D30	6W	730lm	CCT3	60°/80°	ON/OFF	φ90mm	φ110x71mm
DL10-D40	9W	1100lm				φ120mm	φ146x86mm
DL10-D60	15W	1900lm				φ150mm	φ176x86mm
DL10-D80	21W	2650lm				φ200mm	φ226x86mm
DL10-DA60	7W	780lm	3000K-4000K	60°/80°	DALI Dim	φ90mm	φ110x71mm
DL10-DA80	9W	1050lm				φ120mm	φ146x86mm
DL10-DA60	16W	1950lm				φ150mm	φ176x86mm
DL10-DA80	22W	2700lm				φ200mm	φ226x86mm

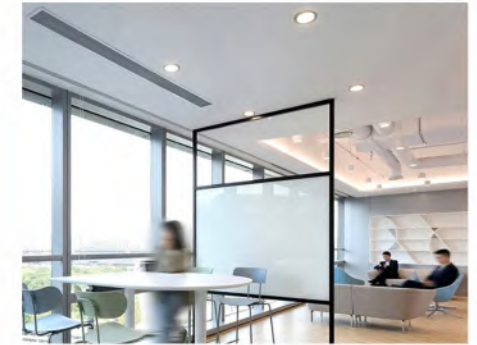

Application

Mall, Hall, Meeting Room, Hotel etc.

DALI version



EIFFEL - EMERGENCY



Application
Mall, Hall, Meeting Room, Hotel etc.

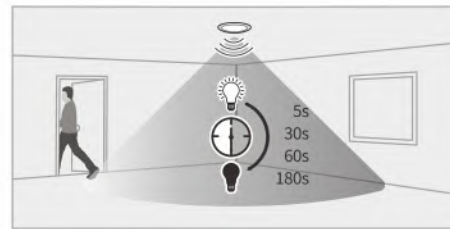

Features

- UGR<19/22
- Aluminum reflector
- CCT selectable
- High lighting efficiency 120lm/W
- Emergency response time: 3 hours
- IP54 for room side
- Tool free installation
- 50000hrs lifespan, 5 years warranty

Module design

The module can work with different trims



Quick install

Screw free
Loop in loop out



CCT3

CCT3 changeable switch on back



Power selectable

Dip-switch change the power

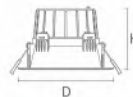

Model	Wattage	Lumen	CCT	Beam	Cut hole	Dimensions
DL10-EM6006	6W	700lm	3000K-4000K	60°/80°	φ90mm	φ110x71mm
DL10-EM8009	9W	1050lm			φ120mm	φ146x86mm
DL10-EM6015	15W	1850lm			φ150mm	φ176x86mm
DL10-EM8021	21W	2650lm			φ200mm	φ226x86mm

EIFFEL



Application
Home, Office, Shop, Hotel etc.

Features

- UGR<19/22
- Aluminum reflector
- CCT selectable
- High lighting efficiency 120lm/W
- IP54 for room side
- Tool free installation
- 50000hrs lifespan, 5 years warranty

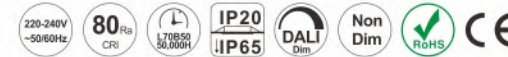

Model	Wattage	Lumen	CCT	Beam	IP Rate	Dimensions
DL013-A01C	6W	650lm	CCT2	80° (UGR<22) 60° (UGR<19)	IP65	φ95x100mm
DL013-A02C	10W	1000lm				φ123x120mm
DL013-A03C	15W	1800lm				φ155x140mm
DL013-A04C	21W	2500lm				φ204x189mm

MULTI-FIT FLAT DOWNLIGHT



Quick install
Screw free
Loop in loop out

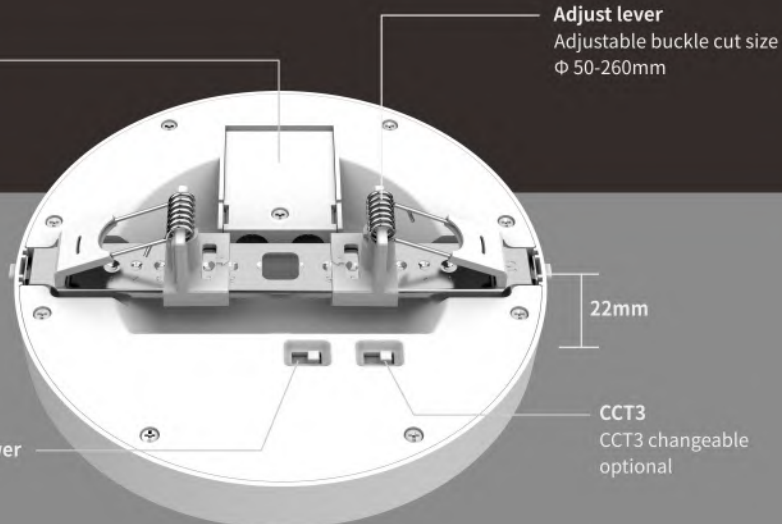

Adjust lever
Adjustable buckle cut size
Φ 50-260mm

22mm

CCT3
CCT3 changeable optional

Multi-power



Bezels optional:
Detachable trim bezels of
4 colors.



PIZZA



Application

Corridor, Aisle, Circulation area

Features

- Adjustable buckle cut size Φ 50-260mm
- CCT3 switch on the back
- High light efficiency 100-120lm/w
- Dimming, non-dimming, multi-power Dali, Emergency is optional
- Black, silver, chrome and brushed nickel bezel optional
- Slim body height 22mm
- 50,000H

Cut Out

For φ50mm-φ260mm cut hole



Ultra-slim

The ultra-slim design satisfies a narrow space with more elegance

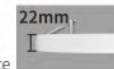

CCT3 & Multi-power

CCT3 & Multi-power changeable switch on back



Model	Wattage	Lumen	CCT	Beam	Cut hole	Dimensions
DA50M-6A	6W	600lm/750lm			φ50-125mm	φ165x22mm
DA50M-12A	12W	1200lm/1500lm			φ50-125mm	φ165x22mm
DA65M-18A-01	18W	1800lm/2300lm	3000K-4000K-6500K	110°	φ65-185mm	φ217x22mm
DA65M-18A-02	18W	1900lm/2400lm			φ65-260mm	φ290x22mm
DA95M-23A	23W	2450lm/3200lm			φ65-260mm	φ290x22mm
DA50M-12B	9W-18W	1100lm/2400lm	3000K-4000K	110°	φ65-185mm	φ217x22mm
DA65M-18B	15W-23W	2000lm/3200lm			φ65-260mm	φ290x22mm

PIZZA-DALI

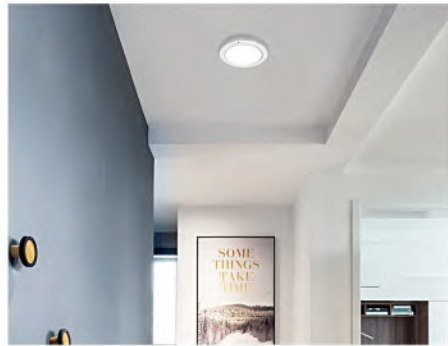

Application

Corridor, Aisle, Circulation area

Features

- Adjustable buckle cut size Φ 65-260mm
- CCT3 switch on the back
- High lighting efficiency 100-120lm/w
- DALI dimming, multi-power optional
- Black, silver, chrome and brushed nickel bezel optional
- Slim body height 22mm

Cut Out

For ϕ 65mm- ϕ 260mm cut hole



Ultra-slim

The ultra-slim design satisfies a narrow space with more elegance



Multi-power

Multi-power changeable switch on driver



Color of Bezels optional

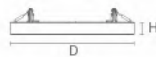

Model	Wattage	Lumen	CCT	Beam	Cut hole	Dimensions
DA65M-D	17.5W	2000lm/2100lm	3000K-4000K	110°	ϕ 65-185mm	ϕ 217x22mm
DA95M-D	22W	2650lm/2800lm	3000K-4000K	110°	ϕ 65-260mm	ϕ 290x22mm

PIZZA SENSOR



Application

Corridor, Aisle, Circulation area

Features

- Adjustable buckle cut size Φ 65-185mm
- High lighting efficiency 100-120lm/w
- PIR infrared sensor, you can set the off time 5s/30s/60s/180s after leaving

Cut Out

For ϕ 65mm- ϕ 185mm cut hole



Ultra-slim

The ultra-slim design satisfies a narrow space with more elegance

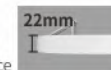

PIR infrared Sensor

Can set light off time 5s/30s/60s/180s after leaving

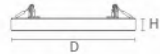
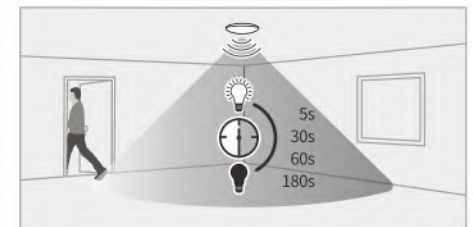
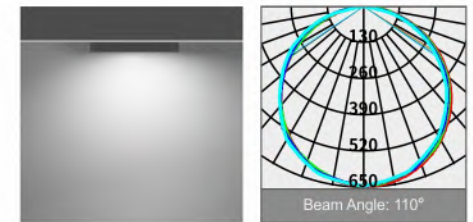

Model	Wattage	Lumen	CCT	Beam	Cut hole	Dimensions
DA65M-P	9W-18W	900lm-1800lm	CCT3	110°	ϕ 65-185mm	ϕ 227x22mm

PIZZA EMERGENCY



Application
Corridor, Aisle, Circulation area

Features

- Adjustable buckle cut size Φ 65-185mm
- Emergency response time: 3 hours
- High lighting efficiency 100-120lm/w
- Power failure can be automatically lit up

Cut Out

For Φ 65mm- Φ 185mm cut hole

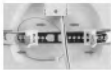

Ultra-slim

The ultra-slim design satisfies a narrow space with more elegance

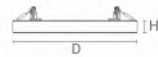
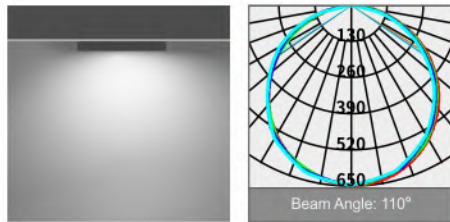
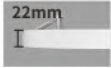

Model	Wattage	Lumen	CCT	Beam	Cut hole	Dimensions
DA65M-E	20.5W	2000lm/2100lm	3000K-4000K	110°	Φ 65-185mm	Φ 217x22mm
DA95M-E	25.5W	2800lm/3000lm	3000K-4000K	110°	Φ 65-260mm	Φ 290x22mm



Ultra-thin Module Spotlight

MAGIC



Module (COB)

Eco module



Reflector
Φ68mm: 6W
Φ78mm: 10W



Lens
Φ68mm: 6W
Φ78mm: 10W



Reflector
Φ68mm: 6W
Φ78mm: 8W



Lens
Φ68mm: 6W
Φ78mm: 8W

Frame



Round Fixed Frame (White)



Round Adjustable Frame (White)



Round Fixed Frame (Black)



Round Adjustable Frame (Black)



Square Fixed Frame (White)



Square Adjustable Frame (White)



Square Fixed Frame (Black)



Square Adjustable Frame (Black)



Round Fixed Deep Frame (White)



Round Fixed Deep Frame (White+Black)



Round Fixed Deep Frame (Black)



Round Fixed Deep Frame (Black+Silver)



Round Fixed Deep Frame (White+Mirror)



Round Fixed Deep Frame (White+Gold)



Round Fixed Deep Frame (Black+Mirror)



Round Fixed Deep Frame (Black+Gold)

Ultra-thin Module Spotlight

2.5'

3'

NEW



KEY FEATURES

- IP65(Front only) fixed, tiltable, low glare trims optional
- Die-casting trim and housing
- Air tight comply with BBC Rt2012 / RE2020 thermal regulation
- Replaceable lighting source and driver
- Multi-power design
- >100LM/W
- Can be covered by insulation material
- Insulation coverable
- 5 years warranty



Specifications

Module	Module (COB)	Eco module
Total Power	6W / 10W	6W/8W
Lumen	650lm/1100lm	650lm/850lm
CCT Changeable	2700K-3000K-4000K	
Beam angle	38°	

DC Connector & CCT Switch



DC Connector



CCT Switch

Dimensions

Round (Fixed / Adjustable)	
	6W D:90mm H:36mm Cut: Φ68mm
	10W D:95mm H:36mm Cut: Φ78mm
Square (Fixed / Adjustable)	
	6W D:90mm H:36mm Cut: Φ68mm
	10W D:95mm H:36mm Cut: Φ78mm
Round Deep (Fixed)	
	6W D:90mm H:52mm Cut: Φ68mm
	10W D:95mm H:60mm Cut: Φ78mm

Combination option



Module Spotlight

Direct insulation coverable



Cover



White Cover



Black Cover

Module (COB)



Reflector
Φ68mm: 6W
Φ83mm: 10W



Lens
Φ68mm: 6W
Φ83mm: 10W

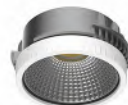

Reflector
Φ68mm: 4.5W
Φ78mm: 7.5W



Lens
Φ68mm: 4.5W
Φ78mm: 7.5W

Eco module

Frame



Round Fixed Frame (White)



Round Adjustable Frame (White)



Round Fixed Frame (Black)



Round Adjustable Frame (Black)



Square Fixed Frame (White)



Square Adjustable Frame (White)



Square Fixed Frame (Black)



Square Adjustable Frame (Black)

MAGIC

Module Recessed Spotlight For Northern Euro and France



KEY FEATURES

- Comply with BBC RT2012/RE2020
- Can be covered with blanket & blown insulation materials
- IP65 for room side and air tight
- Lighting source and driver are replaceable
- Bezels optional
- 8W and 10W for Φ83mm
- Two cutouts: Φ68mm & Φ83mm
- 25° tiltable and 350° rotatable
- 5 years warranty



Specifications

Module	Module (COB)	Eco module
Total Power	6W / 10W	4.5W/7.5W
Lumen	650lm/1100lm	500lm/800lm
CCT Changeable	2700K-3000K-4000K	
Beam angle	38°	

DC Connector & CCT Switch



DC Connector



CCT Switch



Strain relief for both cable and flex tube

Dimensions

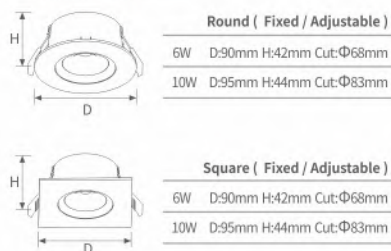

Combination option



ROLAND



Features

- 30° tiltable at all directions
- Insulation material coverable
- SMD solution with CCT selectable and Dim to warm functions
- IP65 for roomside

IP Class

Front IP65



CCT Selectable

CCT3 switch changeable on driver



Triac Dim & Dim to Warm

Dimmable by dimmer



360° Rotation

30° tiltable at all directions



Iron Can

Can be covered directly by insulation material, also blown insulation



Application

Home, Shop, Specialty Stores, Showroom etc.

Finish optional

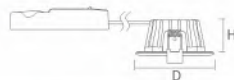
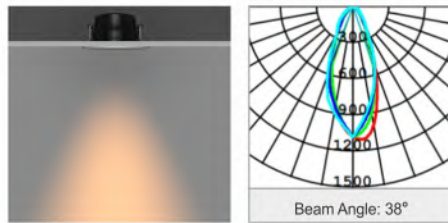
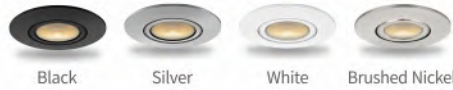

Model	Wattage	Lumen	CCT	Beam	Finish	Cut hole	Dimensions
YA30K-A01DS/DC	8.5W	750lm	2700K/3000K/4000K	38°	Black/White/Silver Brushed Nickel	φ78mm	φ96x44mm
YA25K-A01DS/DC	6W	560lm	CCT3			φ65mm	φ81x41mm
YA25K-A01DW	6W	540lm	2200-2700			φ65mm	φ81x41mm
YA30K-A03FC/FS	8.5W	720lm	2700K/3000K/4000K	38°	Black/White/Silver Brushed Nickel	φ80mm	φ96x63mm
YA25K-A03FC/FS	6W	500lm	CCT3			φ68mm	φ81x63mm

ROLAND



Features

- 30° tiltable at all directions
- Insulation material coverable
- COB solution with alu reflector provides uniform light
- IP65 for roomside

IP Class

Front IP65

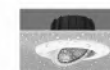

360° Rotation

30° tiltable at all directions



Iron Can

Can be covered directly by insulation material, also blown insulation



Application

Home, Shop, Specialty Stores, Showroom etc.

Finish optional

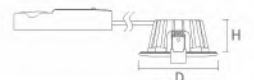
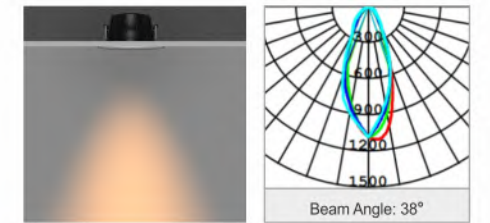
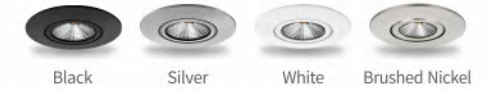

Model	Wattage	Lumen	CCT	Beam	Finish	Cut hole	Dimensions
YA30K-A02	8.5W	850lm	2700K/3000K/4000K	38°	Black/White/Silver/Brushed Nickel	φ78mm	φ96x44mm
YA25K-A02	6W	680lm	2700K/3000K/4000K	38°	Black/White/Silver/Brushed Nickel	φ65mm	φ81x41mm
YA25K-A03	6W	500lm	2700K/3000K/4000K	38°	Black/White/Silver/Brushed Nickel	φ68mm	φ81x63mm

JAMES

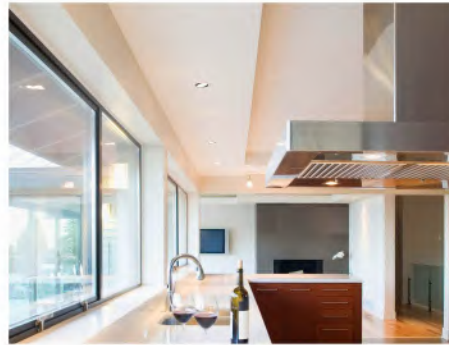

Application

Home, Office, Shop, Hotel etc.

Features

- 30° tiltable at all directions
- SMD solution with CCT selectable and Dim to warm functions

IP Class

Front IP54



360° Rotation

30° tiltable at all directions

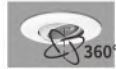

CCT3

CCT3 switch changeable on driver



Finish optional



Black



White

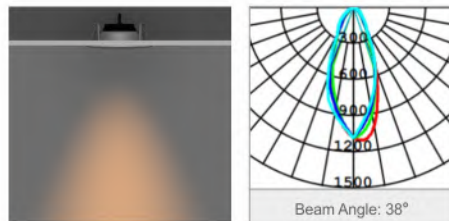

Model	Wattage	Lumen	CCT	Beam	Finish	Cut hole	Dimensions
SL06-A2501DS	6W	550lm	2700K/3000K/4000K	38°	Black/White	φ68mm	φ81x32mm
SL06-A2501DC	6W	550lm	CCT3	38°	Black/White	φ68mm	φ81x32mm

JAMES



Application

Home, Office, Shop, Hotel etc.

Features

- 30° tiltable at all directions
- COB solution with aluminum reflector provides uniform light

IP Class

Front IP54



360° Rotation

30° tiltable at all directions



Finish optional



Black



White

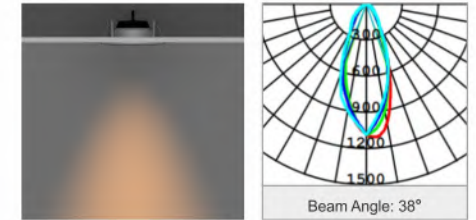

Model	Wattage	Lumen	CCT	Beam	Finish	Cut hole	Dimensions
SL06-A2502DS	6.5W	500lm	3000K/4000K/6500K	38°	Black/White	φ68mm	φ81x32mm

COREIN

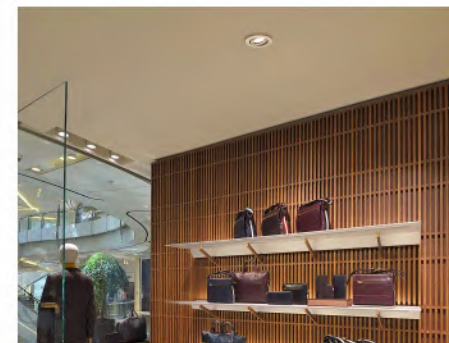

Application

Home, Office, Shop, Hotel etc.



Adjustable / Lens



Fixed / Lens IP65

Fixed / Reflector IP65

Adjustable / Reflector

Features

- Module design, die-casting housing
- Isolated driver
- Beam angle 24°, 36° for choosing
- Fixed and adjustable available
- Lens and reflector versions optional
- 90-100lm/w, 5 years warranty

IP Class

Front IP65 for fixed version



Die-casting

Die-casting heat sink, heat fast

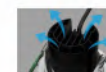



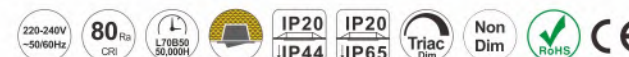
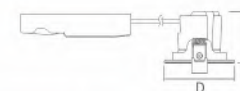
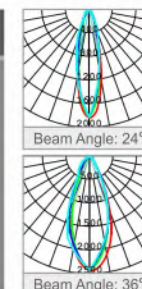





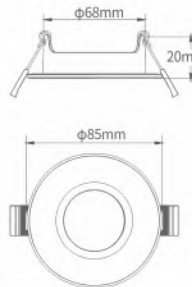

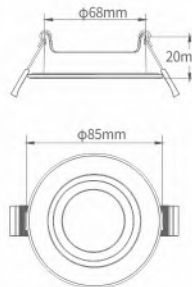
Insulation coverable for 7W

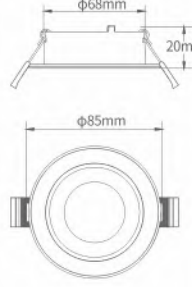

Model	Wattage	Lumen	CCT	Beam	Type	Cut hole	Dimensions
SL07-A2507	7W	780lm		24°/36°	Fixed/Adjustable	φ68mm	φ85x62mm
SL07-A2510	10.5W	1100lm	2700K/3000K/4000K				
SL07-A2512	12.5W	1320lm		36°			

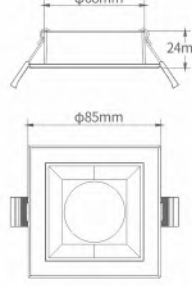
FAIRY- EXTENTION TRIM

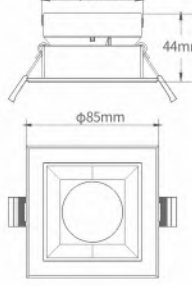
<p>SL005-FR01 (Fixed)</p>  <p>Finish: White Material: Aluminum body Size: $\phi 85 \times 28 \text{mm}$</p>		<p>SL005-FR02 (Adjustable)</p>  <p>Finish: White Material: Aluminum body Size: $\phi 85 \times 28 \text{mm}$</p>	
<p>SL005-FR03 (Fixed)</p>  <p>Finish: White Material: Aluminum body Size: $\phi 85 \times 28 \text{mm}$</p>		<p>SL005-FR04 (Adjustable)</p>  <p>Finish: White Material: Aluminum body Size: $\phi 85 \times 50 \text{mm}$</p>	
<p>SL005-FS01 (Fixed)</p>  <p>Finish: White Material: Aluminum body Size: $85 \times 85 \times 28 \text{mm}$</p>		<p>SL005-FS02 (Adjustable)</p>  <p>Finish: White Material: Aluminum body Size: $85 \times 85 \times 50 \text{mm}$</p>	

COREIN

MODULE RECESSED SPOTLIGHT

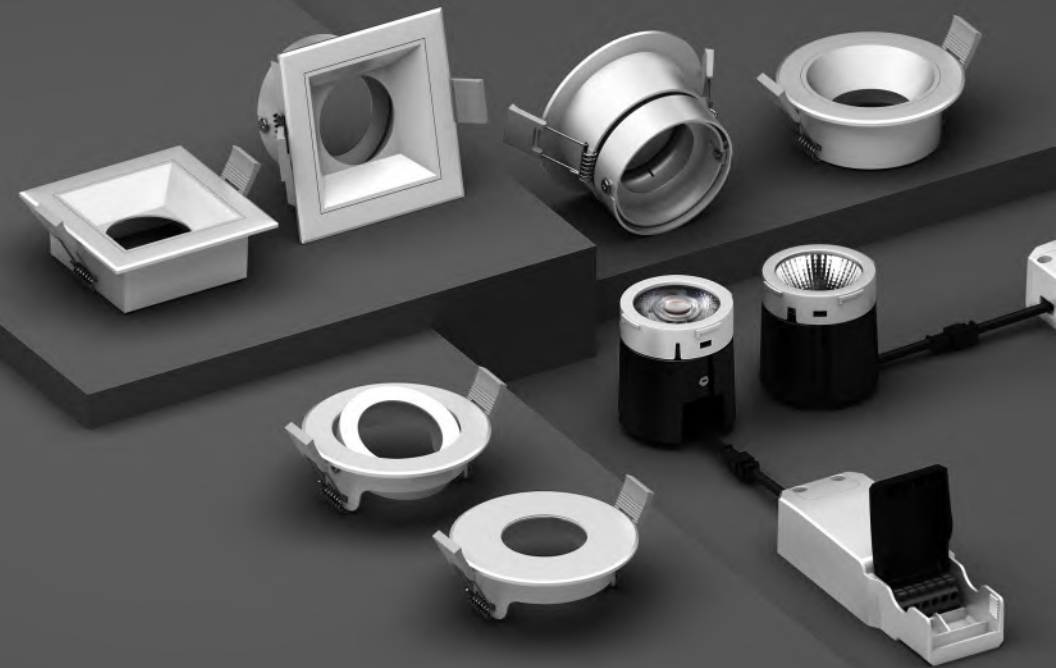

FIRE RATED DOWNLIGHT

Fire resistance test : BS476-20 / BS476-21



Quick install
Screw free
Loop in loop out



Insulation Cover
Can be covered by insulation
directly



Male and female plug
Quick installation and can
easy change to other drivers



90 min anti-fire test



Front CCT3 Switch
2700K-6500K



Anti-glare design
Deep anti-glare

Accessories

Detachable trim bezels of 4 colors.



Brushed Nickel Chrome Silver Black



CLOVER V



IP65



Application

Home, Office, Shop, Hotel etc.

Features

- 90 min anti-fire test
- Up to 300mm height insulation coverable insulation material
- IP65 water-proof
- CCT3 changeable optional
- 3pin loop in and loop out
- Wifi function available
- Low profile design, good for narrow space



Fire-rated

Pass 90min anti-fire test



CCT3

Front switch to change the CCT



Quick install

Screw free
Loop in loop out



Color of Bezels optional



Brushed Nickel Chrome Silver Black

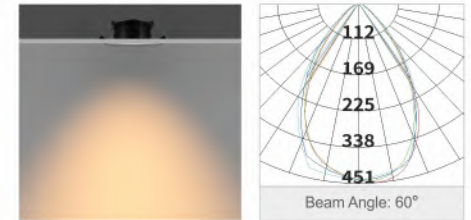

Beam Angle: 60°

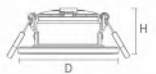

Model	Wattage	Lumen	CCT	Beam	Cut hole	Dimensions
SL002-C01S	6W	500lm	3000K/4000K/6500K	60°	φ68mm	φ88x40mm
SL002-C01C	6W	500lm	CCT3			

CLOVER IV



IP65



Application

Home, Office, Shop, Hotel etc.

Features

- 90 min anti-fire test
- Up to 300mm height insulation coverable insulation material
- IP65 water-proof
- CCT3 changeable optional
- 3pin loop in and loop out

Color of Bezels optional



Brushed Nickel Chrome Silver Black

Fire-rated

Pass 90min anti-fire test



Quick install

Screw free
Loop in loop out



CCT3

Front switch to change the CCT

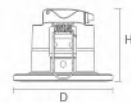
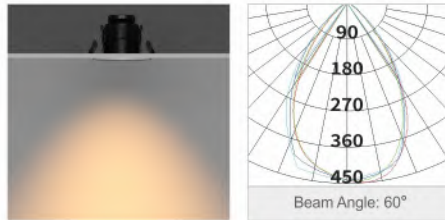

Model	Wattage	Lumen	CCT	Beam	Cut hole	Dimensions
SL002-B01S	6W	500lm	3000K/4000K/6500K	60°	φ68mm	φ88x64mm
SL002-B01C	6W	500lm	CCT3			

CLOVER III



IP65

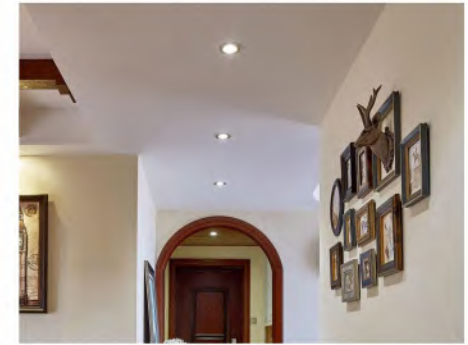

Application

Home, Office, Shop, Hotel etc.

Features

- 90 min anti-fire test
- Up to 300mm height insulation coverable insulation material
- CCT3 changeable optional
- 3pin loop in and loop out
- Separated isolated driver with built in terminal
- Male & female plug between driver and lamp
- Wifi version optional

Color of Bezels optional



Brushed Nickel Chrome Silver Black

Fire-rated

Pass 90min anti-fire test



Quick install

Screw free
Loop in loop out



CCT3

Front switch to change the CCT

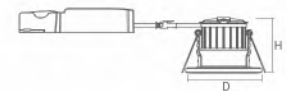
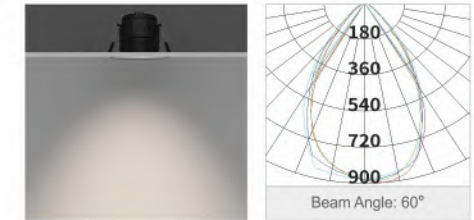

Model	Wattage	Lumen	CCT	LED Type	Beam	Cut hole	Dimensions
SL002-A03S	8.5W	600lm	3000K/4000K/6500K	COB	60°	φ70mm	φ88x65mm
SL002-A03C	8.5W	600lm	CCT3	SMD	60°	φ70mm	φ88x65mm

ROLAND III

ROLAND V



Application

Home, Office, Shop, Hotel etc.

Finish optional

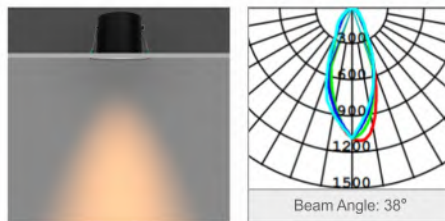

Features

- 90 min anti-fire test
- CCT3 and dimming
- Tooling free installation
- Irradiation angle 360° horizontal adjustment, 30° tilt adjustment
- Separate isolated power supply connect lamp with connect terminal
- Can be used as fire rated down light with a iron can cover

Fire-rated

Pass 90min anti-fire test



360° Rotation

30° tiltable at all directions



CCT3

CCT3 switch changeable on driver

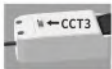

Iron Can

Can be covered directly by insulation material, also blown insulation

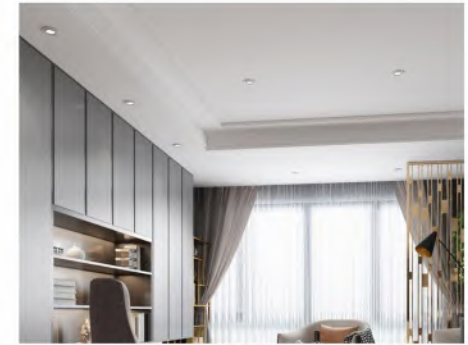

Application

Home, Office, Shop, Hotel etc.

Finish optional

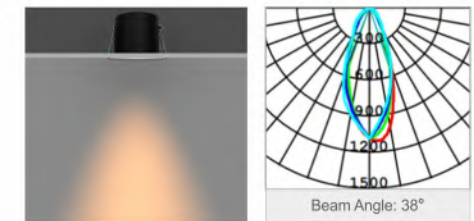

Features

- 90 min anti-fire test
- CCT3 and dimming
- Tooling free installation
- Irradiation angle 360° horizontal adjustment, 30° tilt adjustment
- Separate isolated power supply connect lamp with connect terminal
- Can be used as fire rated down light with a iron can cover

Fire-rated

Pass 90min anti-fire test



360° Rotation

30° tiltable at all directions



CCT3

CCT3 switch changeable on driver

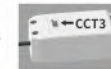

Iron Can

Can be covered directly by insulation material, also blown insulation



Model	Wattage	Lumen	CCT	Beam	Finish	Cut hole	Dimensions
SL360-A03FC	8.5W	720lm	CCT3	38°	Black/White/Silver	φ80mm	φ96x63mm
SL360-A03FS	8.5W	720lm	3000K/4000K/6500K				

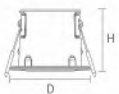

Model	Wattage	Lumen	CCT	Beam	Finish	Cut hole	Dimensions
SL361-A03FC	6W	500lm	CCT3	38°	Black/White/Silver	φ68mm	φ81x63mm
SL361-A03FS	6W	500lm	3000K/4000K/6500K				

FRD-1

FRD-2



KEY FEATURES

- 30 / 60 / 90 min anti-fire test for solid joist and I-joist
- IP65 with lens design
- Twist & lock Bezels
- CCT switchable (2700K / 3000K / 4000K)
- Isolated driver, 40mm height
- Tool free 3 loop in 3 loop out
- Can be covered by insulation material
- 5 years warranty



Specifications

Modle	SL12-A25
Total Power:	6W
Size:	Φ86x40mm
Cutout	Φ68mm
Lumen:	600lm
CCT Changeable:	2700K-3000K-4000K
Beam angle:	60°

Dimensions

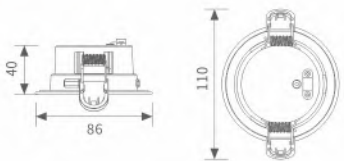

Driver option

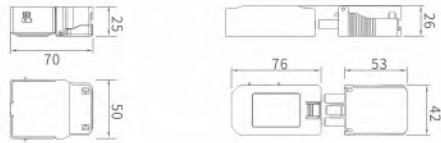

Frame option



KEY FEATURES

- 30 / 60 / 90 min anti-fire test for solid joist and I-joist
- IP65 with reflector design
- Twist & lock Bezels
- CCT switchable (2700K / 3000K / 4000K)
- Isolated driver, 40mm height
- Tool free 3 loop in 3 loop out
- Can be covered by insulation material
- 5 years warranty



Specifications

Modle	SL12-B25
Total Power:	6W
Size:	Φ86x40mm
Cutout	Φ68mm
Lumen:	620lm
CCT Changeable:	2700K-3000K-4000K
Beam angle:	60°

Dimensions

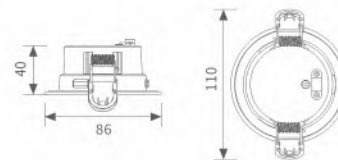

Driver option

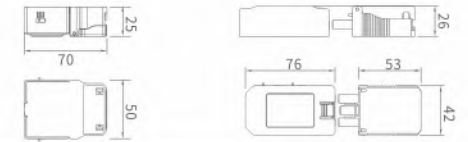

Frame option



MIRANDA

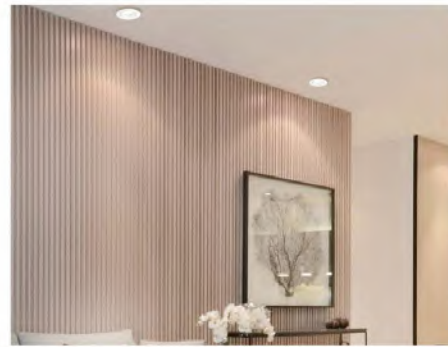

Application

Home, Office, Shop, Hotel etc.

Color of Reflector optional

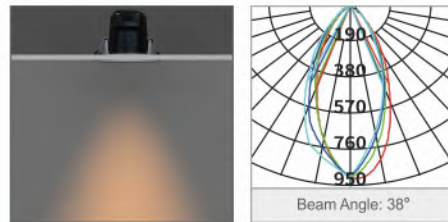

Features

- Deep recessed and anti-glare
- Die-casting housing, good heat dissipation
- Dimming and IP65 / IP44 optional
- 3CCT is optional

Water-proof

Front waterproof IP44/IP65 available



Quick install

Screw free
Loop in loop out

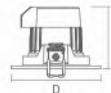

Model	Wattage	Lumen	CCT	Beam	Type	IP Rate	Cut hole	Dimensions
SL015-W044	9W	700lm	3000K/4000K/6500K	38°	Adjustable	IP44	φ68mm	φ86x62mm
SL015-N044	9W	650lm	3000K/4000K/6500K	38°	Fixed	IP44	φ68mm	φ86x62mm
SL015-W065	9W	700lm	3000K/4000K/6500K	38°	Fixed	IP65	φ68mm	φ86x62mm
SL015-N065	9W	650lm	3000K/4000K/6500K	38°	Fixed	IP65	φ68mm	φ86x62mm

MINI EYES



Application

Wardrobe, Cupboard, Bookcase, Cabinet , Indoor space.



Finish optional



Features

- Die-casting aluminum body, good heat dissipation
- Small size for narrow space

Small Size

The 25mm mini size is suitable for a more narrow space



Aluminum Body

Die-casting aluminum body, good heat dissipation



Model	Wattage	Lumen	CCT	Beam	Finish	Cut hole	Dimensions
SL004-A1	1W	70lm	3000K/6500K	36°	Silver/Black/White	φ28mm	φ38x25mm

MINI EYES



IP65



Application

Bathroom Cabinet, Kitchen, Balcony, Canopy etc.

Accessories



Driver & Junction box



RF remote control dimming

Line Art

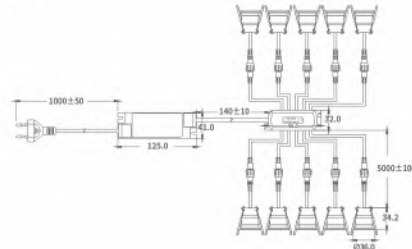

Features

- Die-casting aluminum body, good heat dissipation
- Small size for narrow space
- 12pcs with a junction box and one driver
- RF remote control dimming and group setting

Water-proof

Front waterproof IP65 available

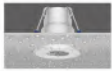

Aluminum Body

Die-casting aluminum body, good heat dissipation



Remote Control

Dimming and group setting



Model	Wattage	Lumen	CCT	Beam	Cut hole	Dimensions
SL004-A3	3W	210lm	3000K/6500K	38°	φ28mm	φ36x34mm



ROSEY



SL08-B01

IP65



SL08-A01

IP65



Application

Home, Office, Shop, Hotel etc.

Color of Bezels optional



Black / Lens



Black / Reflector

Accessories



Junction Box

Features

- IP65 for roomside
- Die-casting trim Slim design for narrow space
- Aluminum reflector and PC lens optional
- CCT selectable
- Built-in driver
- Extra junction box optional

IP Class

Front IP65



CCT3

CCT3 changeable switch on back



Slim body

Slim body for narrow space installation

30mm

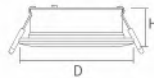
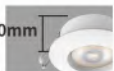

Model	Wattage	Lumen	CCT	Beam	Finish	Cut hole	Dimensions
SL08-A01	6.5W	630lm	CCT3	38°	Black/White	φ75mm	φ85x30mm
SL08-B01	6.5W	630lm	CCT3	38°	Black/White	φ75mm	φ85x30mm

AMBER



YA-25L



YD-25L

IP65



YA-25M

360°



Application

Home, Office, Shop, Hotel etc.

Color of Bezels optional



Features

- different colors of bezels optional
- IP20/IP44/IP65 optional
- Tooling free design save the installation cost
- Ultra-thin design suitable for narrow space

IP Class

Front IP44/IP65



360° Rotation

30° tiltable at all directions



Ultra-slim

Ultra-slim design for narrow space



23.5mm



Model	Wattage	Lumen	CCT	Beam	IP Rate	Cut hole	Dimensions
YD-25L-01	4.8W	400lm	2700K/3000K/4000K	100°	IP65	φ68mm	φ87x35mm
YA-25L-01	4.8W	400lm	2700K/3000K/4000K	38°	IP20	φ68mm	φ87x24mm
YA-25M-01	4.8W	400lm	2700K/3000K/4000K	38°	IP44/IP20	φ68mm	φ87x30mm

Accessories



Can be installed directly into the insulation



Plastic insulation cover



Junction Box

Line Art

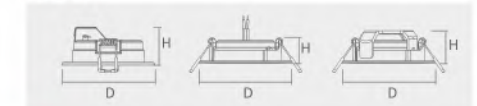

SOFIA

DY25H-B01

DY25H-C01

DY25H-A01



Features

- Up to 185lm/W reach CLASS A
- Different colors bezels optional
- IP20/IP44/IP65 optional
- Screw free design save the installation cost
- Excellent dimming performance compatible with leading edge and trialing edge dimmers
- Can be installed directly into the insulation with the extra frame



Model	Wattage	Lumen	CCT	Beam	IP Rate	Cut hole	Dimensions
DY25H-A01	7W	600lm	3000K/4000K/6500K	100°	IP65	φ70mm	φ87x47mm
YD25H-A02	7W	600lm	CCT3				
DY25H-C01	5W	450lm	3000K/4000K/6500K	38°	IP44	φ70mm	φ87x47mm
YD25H-C02	5W	450lm	CCT3				
DY25H-B01	5W	450lm	3000K/4000K/6500K	100°	IP20	φ70mm	φ87x47mm
DY25H-C01 CLASS A	2.7W	500lm	3000K/4000K/6500K	38°	IP44	φ70mm	φ87x47mm

AVALOR



SL05-C25 (Fixed)

IP65



SL05-B25 (Fixed)

IP65



SL05-A25 (Adjustable)

Features

- Different colors bezels optional
- IP44/IP65 optional
- Screw free design save the installation cost
- Excellent dimming performance compatible with leading edge and trialing edge dimmers

IP Class

Front IP44/IP65



CCT3

CCT3 changeable switch on back and on wall

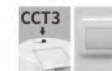

Quick install

Screw free
Loop in loop out

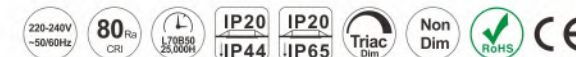

Model	Wattage	Lumen	CCT	Beam	IP Rate	Cut hole	Dimensions
SL05-A25D/C25D	5.5W	550lm	3000K/4000K/6500K	38°/60°	IP44/IP65	φ68mm	φ87x47mm
SL05-A25C/C25C	5.5W	550lm	CCT3				
SL05-B25D	6.5W	600lm	3000K/4000K/6500K	100°	IP65	φ68mm	φ87x47mm
SL05-B25C	6.5W	600lm	CCT3				

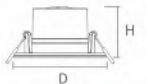

Application

Home, Office, Shop, Hotel etc.

Color of Bezels optional



Accessories



Junction Box

AVALOR



Application
Home, Office, Shop, Hotel etc.

Color of Bezels optional



Features

- Different colors bezels optional
- IP44/IP65 optional
- Screw free design save the installation cost
- Excellent dimming performance compatible with leading edge and trialing edge dimmers

IP Class

Front IP44/IP65



CCT3

CCT3 changeable switch on back

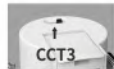

Quick install

Screw free
Loop in loop out

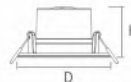

Model	Wattage	Lumen	CCT	Beam	IP Rate	Cut hole	Dimensions
SL05-D25-IP65	5.5W	560lm	3000K/4000K/6500K	38°	IP65	φ68mm	φ87x47mm
SL05-D25-IP44	5.5W	560lm	3000K/4000K/6500K	38°	IP44	φ68mm	φ87x47mm

CLIO

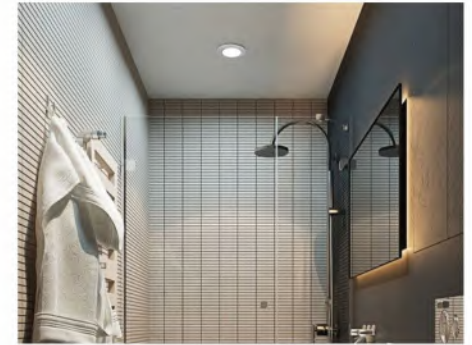

Application
Home, Office, Shop, Hotel etc.

Color of Bezels optional



Features

- Different colors bezels can be changed easily
- IP44 and IP65 can be used into wet applications
- Tooling free design save the installation cost
- Excellent dimming performance compatible with leading edge and trialing edge dimmers
- Can be installed directly into the insulation with the extra frame

IP Class

IP44 and IP65 can be used into wet applications



CCT3

CCT3 changeable switch on back



Quick install

Screw free
Loop in loop out

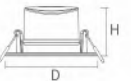

Model	Wattage	Lumen	CCT	Beam	IP Rate	Cut hole	Dimensions
YD35J-A01D	10W	1000lm	3000K/4000K/6500K	100°	IP65		
YD35J-A01C	10W	1000lm	CCT3				
YA35J-B01D	9W	800lm	3000K/4000K/6500K	38°	IP44	φ85mm	φ105x59mm
YA35J-B01C	9W	800lm	CCT3				
YD35J-D01S	8W	700lm	3000K/4000K/6500K	100°	IP54		

BAGEL



DL008-A
(White / Recessed)



DL008-B (White / Surface-mounted)
DL008-B (Brushed Nickel / Surface-mounted)
DL008-A (Brushed Nickel / Recessed)

Features

- Slim body, 24mm height
- Constant current output
- 6pcs with a junction box and one driver
- White and brushed nickel color optional
- Easy wiring and installing

Ultra-slim

Ultra-slim design for narrow space



2 Installations

2 installation: Recessed and surface-mounted

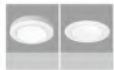

External Drive

6pcs with a junction box and one driver



Application

Wardrobe, Cupboard, Bookcase, Cabinet.

Accessories



Driver & Junction box

Line Art

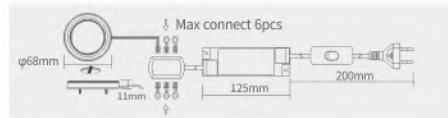

Model	Wattage	Lumen	CCT	Beam	Finish	Installation	Cut hole	Dimensions
DL008-A	2.5W	190lm	3000K	100°	White/Brushed Nickel	Recessed	φ63mm	φ68x11mm
DL008-B	2.5W	190lm	3000K	100°	White/Brushed Nickel	Surface-mounted	/	φ68x11mm



DECO SPOT LIGHT

Modular design

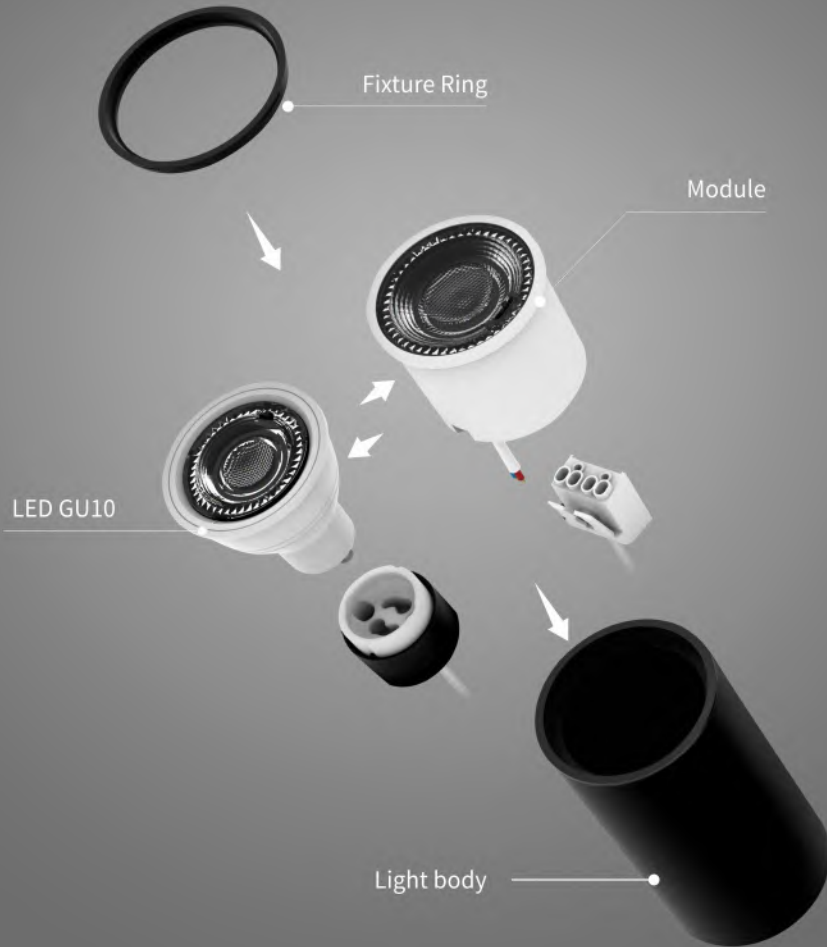

PEGGY



SP001-A03B



SP001-A01B



SP001-A02B



SP001-A04B



Application

Home, Office, Shop, Hotel etc.

Line Art

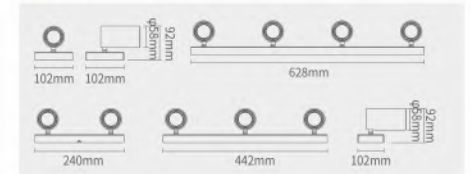

Features

- Surface mount design
- Easy to change the light source
- Dimmable and CCT optional
- White and black body optional
- 350° rotatable

350° Rotatable

Vertically tilt 90°, horizontally rotate 350°



Light Source Optional

Can be used with GU10 or module



Model	Wattage	Lumen	CCT	Beam	LED	Dimensions
SP001-A01B	1x5W	450lm	3000K/4000K	38°	GU10/ Module	φ58x102x92mm
SP001-A02B	2x5W	900lm				φ58x240x92mm
SP001-A03B	3x5W	1350lm				φ58x442x92mm
SP001-A04B	4x5W	1800lm				φ58x628x92mm

EMILY



SP001-D03B



SP001-D01B

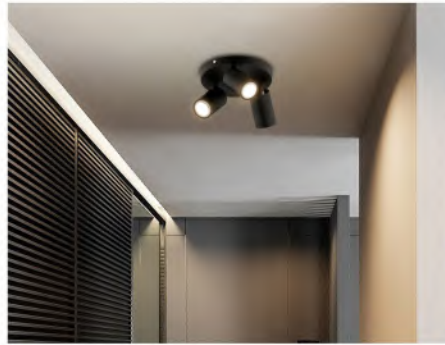

Application

Home, Office, Shop, Hotel etc.

Line Art

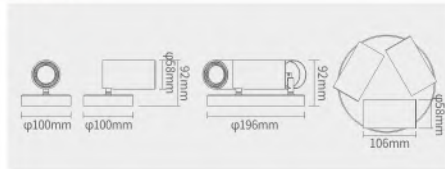

Features

- Surface mount design
- Easy to change the light source
- Dimmable and CCT optional
- White and black body optional
- 350° rotatable

350° Rotatable

Vertically tilt 90°, horizontally rotate 350°



Light Source Optional

Can be used with GU10 or module



Model	Wattage	Lumen	CCT	Beam	LED	Dimensions
SP003-D01B	1x5W	400lm	3000K/4000K/6500K	38°	GU10/ Module	φ58xφ100x92mm
SP003-D03B	3x5W	1200lm				φ58xφ196x92mm

DECO SPOT LIGHT - BOX



GU10



BOX

EMILY II



SP001-E01W



Application

Home, Office, Shop, Hotel etc.



SP001-E02W

SP001-E04W



SP001-E01B

SP001-E02B

SP001-E04B

Line Art

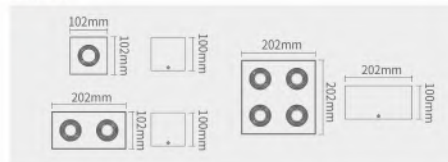

Features

- Surface mount design
- Easy to change the light source
- Dimmable and CCT optional
- White and black body optional
- Adjustable tilt 30° & rotation 350°



Model	Wattage	Lumen	CCT	Beam	Finish	Dimensions
SP001-E01W	1x5W	450lm				102x102x100mm
SP001-E02W	2x5W	900lm	3000K/4000K	38°	White / Black	202x102x100mm
SP001-E04W	4x5W	1800lm				202x202x100mm



NEW

KEY FEATURES

- Can support a flexible and work with module replacement.
- 3 types of installation: Surface mounted / Recessed / Track
- Surface adapter for 3 wire 1 circuit
- Horizontal 355 degree and vertical 90 degree rotation are available.



Specifications

Module	SP004-RD1	SP004-SM1	SP004-TR1
Size	Φ58x143mm	Φ58x163mm	Φ58x143mm
Installation	Recessed	Surface mounted	Track
Cutout	Φ68mm	/	/

Rotatable



Dimensions

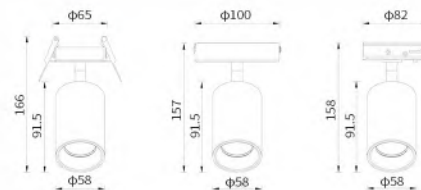

Other Versions Option



GIRAFFE



NEW

KEY FEATURES

- Freely adjustable 355° rotation
- Multiple sizes available
- Housing color : White & Black
- 50000hrs lifespan, 5years warranty



Specifications

Model	SL09-RD1	SL09-SQ1	SL09-SQ2	SL09-SQ3
Total Power	12W	12W	12*2W	12*3W
Size	Φ84x104mm	85x85x116mm	85x158x116mm	85x232x116mm
Cutout	Φ76mm	76x76mm	150x76mm	222x76mm
Lumen	1200lm	1200lm	2400lm	3600lm
CCT	3000K / 4000K			
Beam angle	38°			

Rotatable



Other Versions Option



Dimensions

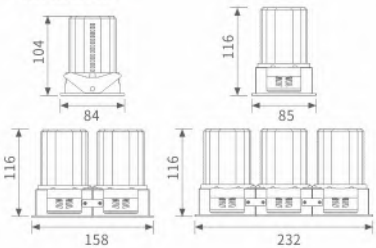

ADELINE



ADELINE



Wood



White+Wood



White



Black



White



Black

Features

- Classical nordic design
- PMMA diffuser, light transmittance is up to 80%
- Switch CCT 2700K - 4000K - 6500K, Triac dimming&CCT3
- 25000 hours lifespan, high lighting efficiency 130-140lm/W
- CE, RoHs and new ERP compliant
- WiFi function is optional, WIIF-RGBCW optional
- Night light mode for RF version

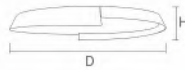

Application

Bedroom, Livingroom, Corridor, Aisle, Circulation area

CCT selectable by dip switch and wall switch



Dimming by dimmer or RF control



Work with Tuya via WIFI



MOON

Indoor Bulkhead

NEW



KEY FEATURES

- Ceiling and wall luminaires for indoor use
- High ingress protection rating: IP54
- 3 diffuser shapes
- Surface mounted, suspending installation optional
- Decorative ring to change the color
- Selectable CCT and power by button on the lamp
- 5 steps power switchable
- Motion sensor, DALI, emergency function optional
- Comply with new ERP and EMC
- Can work with BESA box (51mm & 78mm)
- 5 years warranty

Specifications

Model	CL04-300	CL04-400	CL04-500
Total Power	10W-20W	15W-30W	20W-40W
Size	290x58mm	360x58mm	460x58mm
Lumen	1250-2400lm	1800-3500lm	2400-4600lm
CCT	3000K-4000K		
Beam angle	130°		

Dimensions

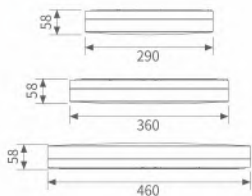

Power & CCT Switchable



Power Switch

CCT Switch

Diffuser option

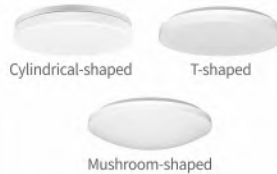

Cylindrical-shaped

T-shaped

Mushroom-shaped

Decorative rings option

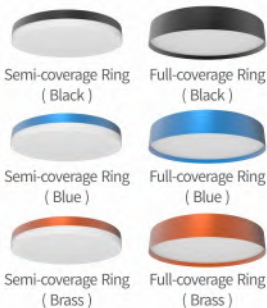

Semi-coverage Ring (Black)

Full-coverage Ring (Black)

Semi-coverage Ring (Blue)

Full-coverage Ring (Blue)

Semi-coverage Ring (Brass)

Full-coverage Ring (Brass)

Installation accessories option



Pendant

Hanger rod



OUTDOOR BULKHEAD

IP66 / IK10

3CCT / Power switch / DALI / Microwave sensor /
Emergency is optional
Fast terminal 3 loop in 3 loop out
Eyelid / Grille accessories for choice
Anti-theft screws protection by locking device

MUFFIN

Outdoor Bulkhead



KEY FEATURES

- IP66 / IK10
- > 100lm/W
- 3CCT / Power switch / DALI / Microwave sensor / Emergency is optional
- Fast terminal 3 loop in 3 loop out
- CRI80 / CRI90
- Eyelid / Grille accessories for choice
- White / Black for choice
- Anti-theft screws protection by locking device
- Replaceable lighting source and driver
- 5years warranty



Specifications

Model	CL03-220-A	CL03-300-A
Total Power	8W-10W-15W	10W-20W-24W
Size	220x63mm	300x63mm
Lumen	1100lm-1350lm-2000lm	1400lm-2700lm-3200lm
CCT	3000K-4000K	
Beam angle	100°	

Dimensions

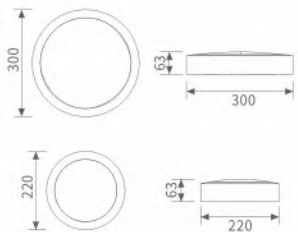

Power & CCT Switchable



Power Switch CCT Switch

Waterproof connector



Frame option

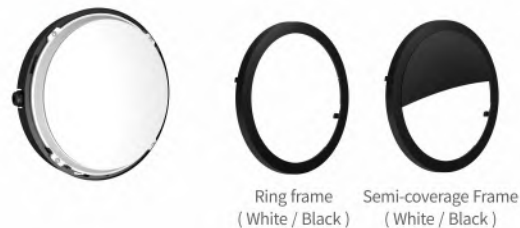

Ring frame (White / Black) Semi-coverage Frame (White / Black)

Outdoor Bulkhead



KEY FEATURES

- IP66 / IK10
- > 100lm/W
- 3CCT / Power switch / DALI / Microwave sensor / Emergency is optional
- Fast terminal 3 loop in 3 loop out
- CRI80 / CRI90
- Eyelid / Grille accessories for choice
- White / Black for choice
- Anti-theft screws protection by locking device
- Replaceable lighting source and driver
- 5years warranty



Specifications

Model	CL03-220-B	CL03-300-B
Total Power	8W-10W-15W	10W-20W-25W
Size	220x63mm	300x63mm
Lumen	400lm-500lm-800lm	500lm-1000lm-1300lm
CCT	3000K-4000K	
Beam angle	100°	

Dimensions

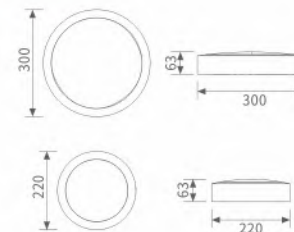

Power & CCT Switchable



Power Switch CCT Switch

Waterproof connector



Frame option

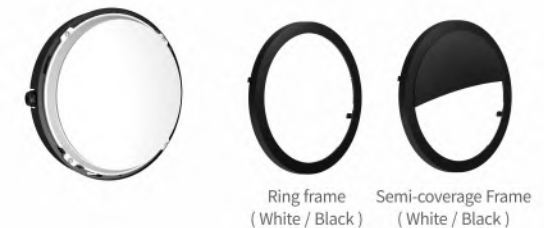

Ring frame (White / Black) Semi-coverage Frame (White / Black)

PIPE

NEW



KEY FEATURES

- UV stabilised polycarbonate with high light transmittance
- High impact resistance of IK08
- PC coating alu to provide better heat dissipation potential
- IP66 Water proof
- Easy and quick installation



Specifications

Modle	LB02-A600	LB02-A1200
Total Power	12W	24W
Lumen	1500lm	3000lm
CCT	2700K/3000K/4000K	
Beam angle	110°	

Dimensions



LB02-A600	L: 600mm	W: 36mm	H: 39mm
LB02-A1200	L: 1200mm	W: 36mm	H: 39mm

Installation diagram

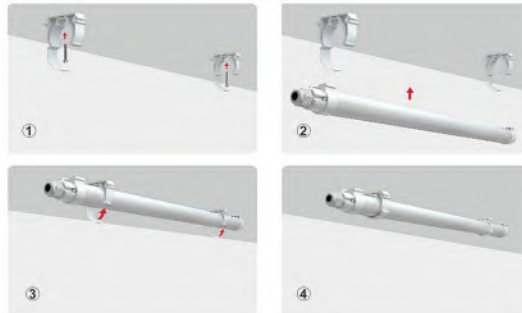

BEN

NEW



KEY FEATURES

- Stabilised polycarbonate with high light transmittance
- High impact resistance of IK08
- IP66 Water proof
- Built-in driver
- Suspending and surface mounetd installaion
- Available length : 600mm,1200mm,1500mm
- Emergency and DALI verison optional



Specifications

Modle	LB03-A600	LB03-A1200	LB03-A1500
Total Power	24W	36W	54W
Lumen	3000lm	4500lm	6800lm
CCT	3000K/4000K		
Beam angle	110°		

Dimensions



LB03-A600	L: 600mm	W: 74mm	H: 61mm
LB03-A1200	L: 1200mm	W: 74mm	H: 61mm
LB03-A1500	L: 1500mm	W: 74mm	H: 61mm



BACKLIT PANEL



KEY FEATURES

- UGR<19 with uniform light
- High cost performance
- Replacement for traditional T5 and T8 fluorescent tube fixtures
- 120lm/W
- 5 sizes for different applications
- Recessed, pending, surface mounted optional



Specifications

Modle	PAL-1-295*295	PAL-1-295*595	PAL-1-295*1195	PAL-1-595*595	PAL-1-595*1195
Total Power	8W	16W	32W	32W	32W
Lumen	1000	2000	3900	3900	3900
CCT	3000k/4000k/6500k				

Dimensions

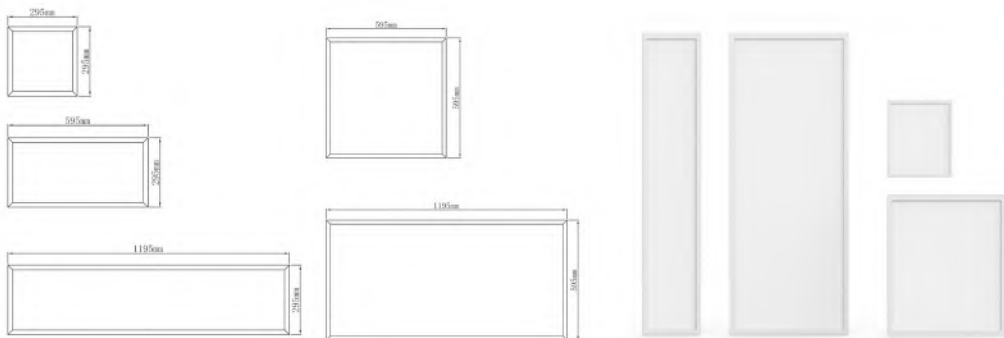

MODULE

Module & Accessories Combination

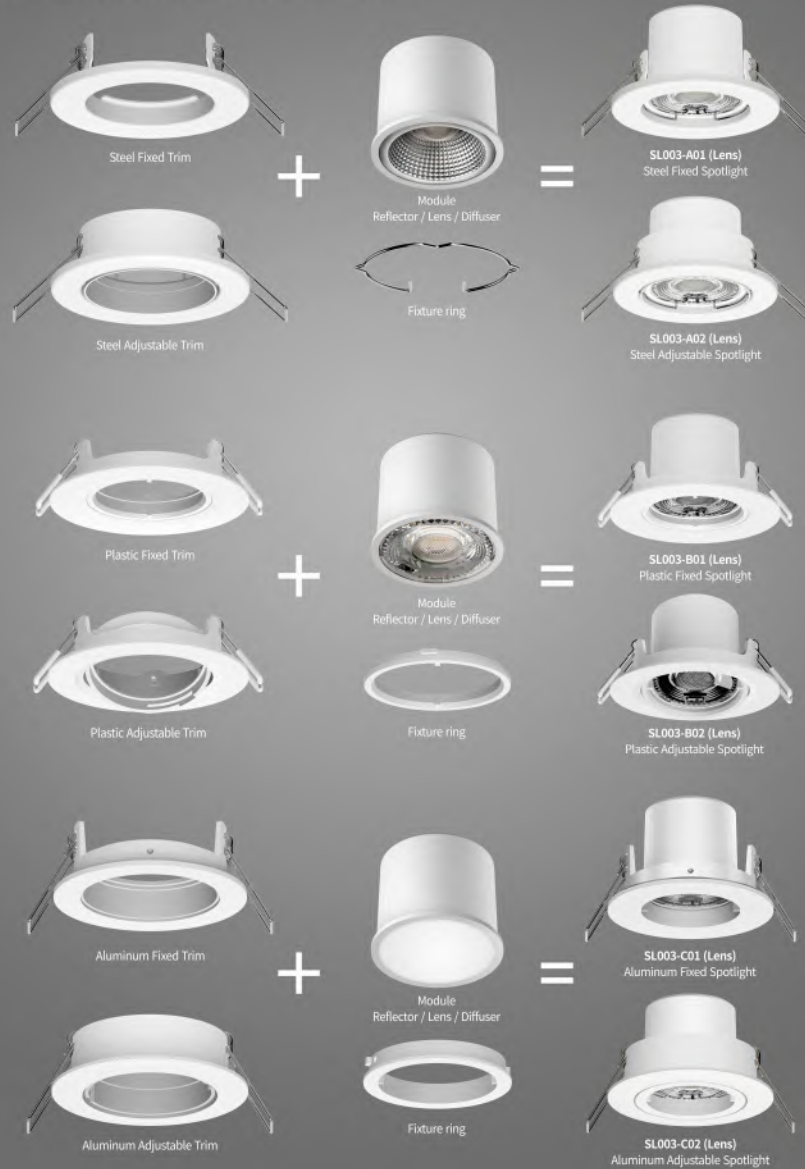

MODULE & EXTENTION TRIM

SL003-A01
SL003-A02
SL003-A03

220-240V ~50/60Hz
80 Ra CRI
L78850 25.600H
Triac Dim.
Non Dim
RoHS
CE

Model	Wattage	Lumen	CCT	Beam	Dimensions
SL003-A01S	6W	500lm	3000K/4000K	100°	φ50x43mm
SL003-A02S	6W	480lm	3000K/4000K	45°	φ50x43mm
SL003-A02C	6W	480lm	CCT2		

Steel Fixed Trim

Finish: White / Brushed Nickel
Material: Steel body
IP Rate: IP20
Size: φ80x27mm

φ68mm

φ68mm
27mm
φ80mm

Steel Adjustable Trim

Finish: White / Brushed Nickel
Material: Steel body
IP Rate: IP20
Size: φ84x25mm

φ68mm

φ68mm
25mm
φ84mm

Plastic Fixed Trim

Finish: White / Black
Material: Plastic body
IP Rate: IP20
Size: φ87x25mm

φ68mm

φ68mm
25mm
φ87mm

Plastic Adjustable Trim

Finish: White / Black
Material: Plastic body
IP Rate: IP20
Size: φ87x25mm

φ68mm

φ68mm
25mm
φ87mm

Aluminum Fixed Trim

Finish: White / Black
Material: Aluminum body
IP Rate: IP44
Size: φ81x30mm

φ68mm

φ68mm
30mm
φ81mm

Aluminum Adjustable Trim

Finish: White / Black
Material: Aluminum body
IP Rate: IP20
Size: φ82x25mm

φ68mm

φ68mm
25mm
φ82mm

REP 50



REP 50



KEY FEATURES

- Module design, compatible market GU10 fixture and different frame
- Can be cover by insulational material With reflector, lens for choice
- Lighting source and driver is replaceable
- COB, SMD led is optional
- On-off / CCT / Triac dimming / Dali is optional
- CCT switchable for SMD lighting source
- Tool free fast connector 3 loop in 3 loop out
- CRI90, $\geq 100\text{lm/W}$



Specifications

Modle	Module-COB	Module-SMD
Total Power	6W / 10W	6W / 8W
Size	$\Phi 50 \times 55\text{mm}$	$\Phi 50 \times 55\text{mm}$
Lumen	650lm / 1100lm	600lm / 850lm
CCT	3000K / 4000K	CCT2: 3000K - 4000K
Beam angle	38°	38° / 45°

Dimensions

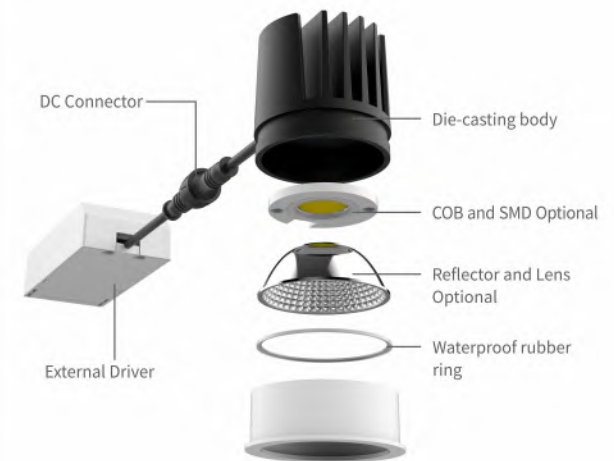
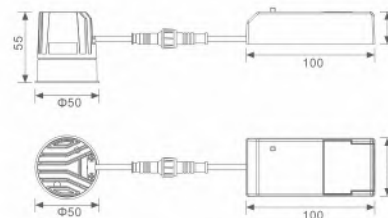

GECO



Application

Restaurant, coffee shop, bar, home, office, shops, hotel etc.

This product works well with the below popular fixtures in Euro market.



The affordable LED spot solution

Features

- CLASS A version: **2.7W 500LM >185lm/W**
- Cob-like lens , more elegant looking
- Compatible with **Leading edge** and **trailing edge** dimmers
- Comply with ERP 2019/2020 and **new EMC** standard in 2022
- Dim and non dim optional
- 2 years warranty

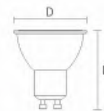

Model	Wattage	Lumen	CCT	Beam	Dimensions
SL003-GU10B01	4.8W	420lm/430lm/450lm	2700K/3000K/4000K	38°	
SL003-GU10B02	4.8W	400lm/410lm/430lm	2700K/3000K/4000K	100°	φ49x55mm
SL003-GU10B03	4.8W	420lm	CCT2	38°	
SL003-GU10CLA	2.7W	500lm	2700K/3000K/4000K	38°	φ49x55mm



NOAH

50000hrs



White / CCT2



Application

Hotel, shops, showroom etc.

Features

- Suitable for sealed fixtures or fixtures under insulation material
- COB-like lens, providing uniform light
- One-piece heatsink, better heat dissipation capability
- Compatible with leading edge and trailing edge dimmers
- CCT selectable
- White, grey color optional
- Ra90, up to 100lm/W
- 50000hrs lifespan, 5years' warranty

Finished optional



White

Grey

Used inside sealed fixtures or fixtures under insulation material

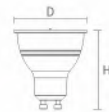

Model	Wattage	Lumen	CCT	Beam	IP Rate	Dimensions
SL003-GU10B01	5W	460lm/470lm/500lm	2700K/3000K/4000K	38°	IP20/IP44	φ50x54mm

